



**When Performance Matters**  
**Rely on Us!**



# Heat Fusion Joining Procedures And Qualification Guide

Gas Distribution, Water, Industrial, Specialty and Energy Products



# PERFORMANCE PIPE

## HEAT FUSION JOINING PROCEDURES

### INTRODUCTION

Performance Pipe, a Division of Chevron Phillips Chemical Company LP, is the functional successor to the operations of Plexco® and Driscopipe® PE piping. As a result, some Performance Pipe products may have the markings of the Plexco®, Driscopipe® or DriscoPlex® PE piping brands.

This Manual describes procedures and guidelines for joining Performance Pipe products using butt fusion, saddle fusion and socket fusion joining techniques. All procedures and guidelines in this document are in alignment with ASTM F2620 Standard Practice for Heat Fusion Joining of Polyethylene Pipe and Fittings

### QUALIFICATION OF PROCEDURE

When used to join Performance Pipe polyethylene gas distribution pipe and fittings, Performance Pipe fusion joining procedures are qualified in accordance with U.S. Department of Transportation Regulation 49 CFR, Part 192, §192.283.

### GAS DISTRIBUTION PRODUCTS

DriscoPlex® 6500 MDPE Piping	Driscopipe® 8100 HDPE Piping	Yellowstripe® 8300 HDPE Piping
DriscoPlex® 8400 HDPE Piping		

All Gas Distribution products listed above are compatible with these procedures. This includes cross fusions of these products (e.g. DriscoPlex® 6500 to Yellowstripe® 8300, etc.)  
**Do not join Driscopipe® 7000 or 8000 PE Piping using these procedures.**  
 Contact Performance Pipe Technical Service for information regarding other Plexco® or Driscopipe® legacy piping products.

### WATER, SPECIALTY, MUNICIPAL AND INDUSTRIAL PRODUCTS

DriscoPlex® 1000 HDPE Piping	DriscoPlex® 4000 HDPE Piping	DriscoPlex® 4800 MDPE Piping
DriscoPlex® 1700 HDPE Piping	DriscoPlex® 4100 HDPE Piping	DriscoPlex® 6300 HDPE Piping
PlatinumStripe® 1800 PE-RT Piping	DriscoPlex® 4600 HDPE Piping	DriscoPlex® 6400 HDPE Piping
DriscoPlex® 3100 HDPE Piping	DriscoPlex® 4700 HDPE Piping	

All Water, Specialty, Municipal and Industrial products listed above are compatible with these procedures.  
**Do not join Driscopipe® 7600 or 8600 PE Piping using these procedures.**  
 Contact Performance Pipe Technical Service for information regarding legacy piping products or products not listed above.

## OVERVIEW

In heat fusion joining, mating surfaces are prepared and simultaneously melted with a hot-plate heater. The heater is removed, and then, the melted surfaces are pressed together and held under pressure. As the molten materials cool, they mix and fuse into a permanent, monolithic joint. Heat fusion procedures require specific tools and equipment based on the fusion type and the sizes of pipe and fittings being joined.

- Butt fusion is used to make end-to-end joints between “butt” or plain-end pipes and fittings that have the same outside diameter and “like wall thickness”.
  - ✓ “Like wall thickness” means that the pipe or fitting ends being butt fused do not exceed one SDR difference (e.g. SDR 9.0 to SDR 11.0). Per ASTM, standard dimension ratio (SDR) is when the outside diameter divided by the minimum wall thickness equals one of the following values: 6.0, 7.3, 9.0, 11.0, 13.5, 17.0, 21.0, 26.0, 32.5 or 41.0.
- Saddle (sidewall) fusion is used to install a branch outlet fitting to the top or side of a pipe main. Tapping tee fittings are usually installed on top of the pipe main, while branch or service saddle fittings are installed on the side of the main. After the fusion area has cooled, the main pipe wall is pierced (tapped) to enable flow through the branch. “Hot tapping” is saddle fusion to a “live” or pressurized main.
- Socket fusion is used to join 4” IPS and smaller tubing and pipe to socket fittings. Socket fittings are available for certain Performance Pipe PE materials.
- ❖ **CAUTION — Performance Pipe polyethylene piping products cannot be joined with adhesives or solvent cement. Joining by hot air (hot gas) welding or extrusion welding techniques and joining by pipe threading are not recommended for pressure service.**

## PRECAUTIONS

### STATIC ELECTRICITY

Polyethylene plastic pipe does not readily conduct electricity. A static electricity charge can build up on inside and outside surfaces and stay on the pipe surface until some grounding device such as a tool or a person comes close enough for the static electricity to discharge to the grounding device.

- Discharging one part of the pipe surface will not affect other charged areas because static electricity does not flow readily from one area to another. Polyethylene pipe cannot be discharged by attaching grounding wires to the pipe.
- ◆ **WARNING – Fire or Explosion – Static electricity discharge can ignite a flammable gas or combustible dust atmosphere.**

A static electricity discharge to a person, a tool or a grounded object close to the pipe surface can cause an electric shock or a spark. That can then ignite a flammable gas or combustible dust atmosphere causing fire or explosion.

- In gas utility applications, static electricity can be a potential safety hazard. **Where a flammable gas-air mixture may be encountered and static charges may be present, such as when repairing a leak, squeezing-off an open pipe, purging, making a connection, etc., arc preventing safety precautions are necessary.**<sup>1</sup> Observe all Company (pipeline operator, utility, contractor, etc.) procedures for static electricity safety and control, including procedures for discharging static electricity and requirements for personal protection.
- Take steps to discharge static electricity from the surface of a polyethylene gas pipe. Such steps include wetting the entire exposed pipe surface with a conductive anti-static liquid or a dilute soap and water solution, then covering or wrapping the entire wetted, exposed pipe surface with grounded wet burlap, conductive poly film or wet tape conductor. The external covering should be kept wet by occasional re-wetting with anti-static solution. The covering or tape should be suitably grounded such as to a metal pin driven into the ground.
- Steps that discharge the outer surface do not discharge the inner surface of the pipe. Squeeze-off, purging, venting, cutting, etc., can still result in a static electricity discharge. When appropriate, ground tools and remove all potential sources of ignition.
- Appropriate safety equipment should be used.
- **Do not use polyethylene pipe for handling dry grain or coal where a static electricity discharge may ignite a combustible dust atmosphere and cause an explosion or fire.**
- Polyethylene pipe is not recommended for pneumatic slurry applications.

## **ELECTRIC TOOLS**

- ◆ ***WARNING – Fire or Explosion – Electric tools or fusion equipment may not be explosion-proof and may ignite a flammable gas or flammable dust atmosphere.***

***DO NOT*** operate electrical devices that are not explosion proof in a flammable gas or flammable dust atmosphere. When a flammable gas-air mixture may be present, observe all gas system operator (pipeline or utility company and contractor) safety procedures for the use of electric tools and equipment.

## **LIQUID HYDROCARBON PERMEATION**

When present, liquid hydrocarbons may permeate (solvate) polyethylene pipe. Liquid hydrocarbon permeation may occur when: 1) liquid hydrocarbons are present in the pipe; 2) where soil surrounding the pipe is contaminated with liquid hydrocarbons; or 3) where liquid hydrocarbon condensates can form in gas pipelines. Heat fusion joining to liquid hydrocarbon permeated pipes may result in a low strength joint.

---

<sup>1</sup> See the *AGA Plastic Pipe Manual For Gas Service 2000*, American Gas Association, 1515 Wilson Boulevard, Arlington, VA 22209.



- 
- ❖ **CAUTION** — *Once polyethylene pipe has been permeated with liquid hydrocarbons, heat fusion or electrofusion joining is not recommended because liquid hydrocarbons will leach out during heating and contaminate the joint. Liquid hydrocarbon permeated polyethylene pipe should be joined using suitable mechanical connection methods. Contact the mechanical joining product manufacturer for connection and installation procedures.*

Liquid hydrocarbon contamination is indicated by a rough, sandpaper-like, bubbly or pockmarked surface when a fusion heating iron is removed from the pipe surface, and it may be indicated by discoloration or by a hydrocarbon fuel odor. See the *PPI Handbook of Polyethylene Pipe* for additional information on permeation and chemical resistance.

### **LEAKAGE AT FUSION JOINTS**

- ◆ **WARNING** – *Correctly made fusion joints do not leak. When pressurized, leakage at a faulty fusion joint may immediately precede catastrophic separation and result in violent and dangerous movement of piping or parts and the release of pipeline contents under pressure. Never approach or attempt to repair or stop leaks while the pipeline is pressurized. Always depressurize the pipeline before making corrections. Faulty fusion joints must be cut out and redone.*

### **HANDLING**

Polyethylene piping is a tough, robust material, but it is not immune to damage. **Improper handling or abuse can damage piping, compromise system performance and result in injury or property damage.** Polyethylene piping should be unloaded and moved with proper handling and lifting equipment. Use fabric slings. Do not use chains or wire ropes. Do not roll or drop pipe off the truck or drag piping over sharp rocks or other abrasive objects. Store piping so that the possibility of mechanical damage is minimized. Visit [www.performancepipe.com](http://www.performancepipe.com) for additional information on handling and storage.

### **FUSION IN COLD WEATHER**

In cold weather, polyethylene becomes more sensitive to impact and is less flexible. Use additional care in handling. When temperatures are cold, avoid sharp impact such as dropping the pipe from moderate heights. Cold pipes will be harder to bend or uncoil.

Butt, Saddle, or Socket Fusion is generally not recommended below -4°F (-20°C) without special provisions such as a portable shelter or trailer or other suitable protective measures with auxiliary heating. In inclement weather and especially in windy conditions, the fusion operation should be shielded to avoid precipitation or blowing snow and excessive heat loss from wind chill. Remove all frost, ice or snow from the OD and ID surfaces of areas to be fused. Surfaces must be clean and dry before fusing.

- Maintain the specified heating tool surface temperature. **Do not increase heating tool surface temperature.**
- Do not apply pressure during zero pressure butt or saddle fusion heating steps.



- Do not increase butt or saddle fusion joining pressure.
- When making a butt fusion joint with the ambient temperature below 3°F(-16°C), pre-heat the pipe ends using a heating blanket or warm air device to elevate the pipe temperature to improve the heating starting condition.
  - With pipe mounted in the fusion machine, an alternate method of pre-heating is to stop the pipe ends within .25-.50 inches (6.4-12.7mm) of the heater plate face to allow the pipe ends to warm for 30 seconds to 2 minutes, depending on the pipe size and wall thickness.
- ❖ **CAUTION - The use of direct application open flame devices, such as torches, for heating polyethylene pipe is prohibited due to the lack of adequate heating control and possibility of damage to the pipe ends.**
- When fusing coiled pipe when the ambient temperature is below 32°F (0°C), it may be required to remove an end section of pipe from the coil and butt fuse on a straight section of pipe to enable correct pipe alignment. Completed joints shall be allowed to cool to ambient temperature before any stress is applied.

When fusing in cold weather, the time required to obtain the proper melt may increase.

- In butt fusion, melt bead size determines heating time. As a result, the procedure automatically compensates when cold pipe requires longer time to form the proper melt bead size.
- For saddle fusion, establish the necessary cold weather heating time by making trial melt patterns in the field on **non-pressurized**, excess pipe that is at field temperature. Use the standard heating time, plus additional heating time in 3-second increments during bead-up, until the proper melt pattern is established on the pipe. A clean wood board or heat shield (“flyswatter”) should be used between the saddle fitting and the heater to avoid heating the fitting when making trial melt patterns.
- In socket fusion, it will be more difficult to fit a cold socket fitting into the heating tool socket face because polyethylene pipe and fittings will contract slightly in the cold. One way to compensate is to warm the socket fitting in the cab of the service truck before use. For the pipe, establish the necessary heating time by making trial patterns on excess pipe that is at field temperature. Use the recommended heating time, plus additional heating time in 3-second increments, until the proper melt pattern is established.

Additional information on fusion in cold weather can be found in Annex 1 of ASTM F2620 *Standard Practice for Heat Fusion Joining of Polyethylene Pipe and Fittings*.

## **KEY FACTORS FOR QUALITY FUSIONS**

Quality fusion requires using all of the required tools and equipment while following all of the steps in the procedure in the correct sequence. Faulty fusion is caused by improper or defective equipment, omitting steps or doing things out of sequence.

Training and experience provide knowledge and proficiency in what to do, what to expect and recognizing potential problems in advance. Inadequately trained or inexperienced persons can produce poor quality fusions and may expose themselves or others to hazards. Federal safety regulations require



that persons making joints in gas systems must be qualified in the pipeline operator's qualified fusion procedures (CFR 49, Part 192).

The key factors below are necessary for quality fusion:

- Fusion tools and equipment must be correct for the job and in proper working order.

Each fusion procedure requires specific tools and equipment to do the job properly. Incorrect or poorly maintained or damaged fusion tools or equipment or using the wrong tools or equipment can cause a poor fusion and may be hazardous. Use only the correct tools and equipment for the job. Do not use defective or improper tools or equipment. Follow the equipment manufacturer's procedures for equipment maintenance.

- The fusion operator must be proficient in tool and equipment use and operation, and proficient in fusion procedure.

The operator should be thoroughly familiar with the tools and equipment and their use and operation. Improper use or an incorrect operating sequence can cause a poor fusion and may be hazardous. Know how to use the equipment and observe the manufacturer's instructions.

- Pipe and fitting surfaces must be clean and properly prepared.

Dirty, contaminated or poorly prepared surfaces that do not mate together properly cannot produce a quality fusion. Clean and prepare the surfaces before joining. If contamination is reintroduced, clean the surfaces again.

- Heating tool surfaces must be clean, undamaged and at the correct surface temperature.

Heating tool faces have non-stick coatings for quick, complete release from melted polyethylene. Dirty or contaminated heating tool faces can cause poor fusion and damaged coatings may not release properly from the melt. Use only wooden implements and clean, dry, lint-free, non-synthetic (cotton) cloths, or paper towels, to clean heating tool faces. Never use spray chemicals or metal tools on heating tool faces.

Heating tool temperatures are specified for each procedure. (Butt fusion and saddle fusion heating tool temperatures are different.) *The specified temperature is the temperature on the surfaces that contact the pipe or fitting being joined, not the heating tool thermometer temperature.* Use a pyrometer or infrared thermometer to check for uniform temperature across both of the component contact surfaces. *(Temperature indication crayons are not preferred. If used, temperature-indicating crayons must never be applied to a surface that contacts a pipe or fitting.)* Uneven temperature may indicate a faulty heater. The heater thermometer measures the internal temperature, which is usually higher than surface temperature; however, heating tool temperature can be verified by checking the thermometer to ensure that the heating tool is maintaining temperature. When checking surface temperature with a pyrometer or infrared thermometer, note the heating tool thermometer reading. Check the heating tool thermometer reading before each fusion to verify that the heating tool is maintaining temperature properly. Incorrect or non-uniform temperature can cause poor fusion; **low heating tool temperature can lead to a blowout during hot tap saddle fusion.**

## **BEFORE YOU START:**

- ✓ Inspect pipe lengths and fittings for unacceptable cuts, gouges, deep scratches or other deleterious defects. Damaged products should not be used.
- ✓ Remove surface damage at pipe ends that could compromise the joining surfaces or interfere with fusion tools or equipment.
- ✓ Be sure all required tools and equipment are on site, in proper working order and fueled up.
- ✓ The pipe and fitting surfaces where tools and equipment are fitted must be clean and dry to facilitate proper fusion and avoid contaminating fusion machine parts. Do not use the facer to remove contamination. Guidance on proper cleaning of PE pipe before fusion is given in ASTM F2620 Appendix X1. Use clean, dry, lint-free, non-synthetic (cotton) cloths, or paper towels, to remove dirt, snow, water and other contamination. If contamination was transferred to the pipe ends during cleaning (soap) or cutting, **before** installing the pipe in the fusion machine, 90% or greater isopropyl alcohol or acetone shall be used to clean the contamination; allow the pipe to dry thoroughly before facing. The use of alcohol or acetone **after** facing the pipe ends is **not** recommended since a properly faced surface should be pure.
- ✓ Shield heated fusion equipment and surfaces from inclement weather and winds. A temporary shelter over fusion equipment and the fusion operation may be required.
- ✓ Relieve tension in the line before making connections.
- ✓ When joining coiled pipe, making an s-curve between pipe coils can relieve tension. In some cases, it may be necessary to allow pipe to equalize to the temperature of its surroundings. Allow pulled-in pipes to relax for several hours to recover from tensile stresses.
- ✓ Pipes must be correctly aligned before making connections.
- ◆ **WARNING – Impact Hazard – Do not bend pipe into alignment against open butt fusion clamps. The pipe may spring out and cause injury or damage. Pipe must be aligned before placing it into butt fusion equipment.**

## **BUTT FUSION**

### **SET-UP PARAMETERS**

#### **HEATING TOOL SURFACE TEMPERATURE - MINIMUM 400°F – MAXIMUM 450°F (204–232°C)**

Heating tool surfaces must be clean and up to temperature before beginning the fusion procedure. All points on both heating tool surfaces where the heating tool surfaces will contact the pipe or fitting ends must be within the prescribed minimum and maximum temperatures.

#### **GAUGE PRESSURE**

Gauge pressure is the pressure required for fusion. For hydraulic machines, the gauge pressure is a function of interfacial pressure, fusion surface area, machine's carriage cylinder size and drag pressure.





When calculated, gauge pressure is what the operator will input into the fusion machine. The total effective piston area can be obtained from the machine manufacturer. The drag pressure is the pressure that is required to overcome resistance to movement in the carriage. **Interfacial pressure and gauge pressure are not the same.** Manually operated machines do not require a calculation for gauge pressure. Below is the equation used to calculate for Gauge Pressure in psi. **A slide rule or a gauge pressure calculator obtained from the machine's manufacturer can be a substitute for this calculation.**

$$P_G = \frac{\left[ OD^2 \times \pi \times \left( \frac{1}{DR} - \frac{1}{DR^2} \right) \right] \times IFP}{TEPA} + P_D$$

- P<sub>G</sub> = Gauge Pressure, psi
- OD = Outside Diameter, in.
- DR = Dimension Ratio
- IFP = Interfacial Pressure,  
60 – 90 psi (4.14 – 6.21 bar)
- P<sub>D</sub> = Drag Pressure, psi
- TEPA = Total Effective Piston Area, in<sup>2</sup>

## PROCEDURE

- **Secure.** Clean the inside and outside of the component (pipe or fitting) ends by wiping with a clean, dry, lint-free, non-synthetic (cotton) cloth, or paper towel. Remove all foreign matter. Align the components with the machine, place them in the clamps and then close the clamps. **Do not force pipes into alignment against open fusion machine clamps.** (When working with coiled pipe, if possible “S” the pipes on each side of the machine to compensate for coil curvature and make it easier to join.) Component ends should protrude past the clamps enough so that facing will be complete. Bring the ends together and check high-low alignment. Adjust alignment as necessary by tightening the higher side pipe clamp. On larger pipes, toe-in may need to be removed before fusion (See ASTM F2620 X1.6).
- **Face.** Place the facing tool between the component ends and face them to establish smooth, clean, parallel mating surfaces. Complete facing produces continuous circumferential shavings from both ends. Face until there is a minimal distance between the fixed and moveable clamps. Some machines have facing stops. If stops are present, face down to the stops. Remove the facing tool and clear all shavings and pipe chips from the component ends. **Do not touch the component ends with your hands after facing.**
- **Align.** Bring the component ends together, check alignment and check for slippage against fusion pressure. Look for complete contact all around both ends with no detectable gaps and outside diameters in high-low alignment. The maximum high-low misalignment is to be less than 10% of the pipe minimum wall thickness. If necessary, adjust the high side pipe by tightening the high side clamp. Do not loosen the low side clamped pipe because components may slip during fusion. Re-face if high-low alignment is adjusted.
- **Melt.** Verify that the heating tool is maintaining the correct temperature. Place the heating tool between the component ends and move the ends against the heating tool. The initial contact should be under fusion pressure to ensure full contact then reduce to contact pressure only. Contact pressure results in the minimum force (essentially zero pounds) to ensure the heating tool and

component ends remain in contact. When using hydraulic fusion machines, contact pressure equates to “drag pressure” or heating pressure; see ASTM F2620 for additional information on the topic.

**On larger sizes (14” and larger), hold fusion pressure until an indication of melt is observed around the pipe ends before reducing pressure to contact pressure.**

Hold the ends against the heating tool **without force**. Beads of melted polyethylene will form against the heating tool at the component ends. Use **Table 1** to determine the minimum melt bead size from the pipe OD. When the proper melt bead size is formed, quickly separate the ends and remove the heating tool. This process should be completed within the recommended time in **Table 2**.

**Table 1: Minimum Melt Bead Size**

Pipe OD, in. (mm)	Minimum Melt Bead Size, in. (mm)
< 2.37 (60)	1/32 (1)
≥ 2.37 (60) ≤ 3.5 (89)	1/16 (1.5)
> 3.5 (89) ≤ 8.62 (219)	3/16 (5)
> 8.62 (219) to ≤ 12.75 (324)	1/4 (6)
> 12.75 (324) to ≤ 24 (610)	3/8 (10)
> 24 (610) to ≤ 36 (900)	7/16 (11)
> 36 (900) to ≤ 65 (1625)	9/16 (14)

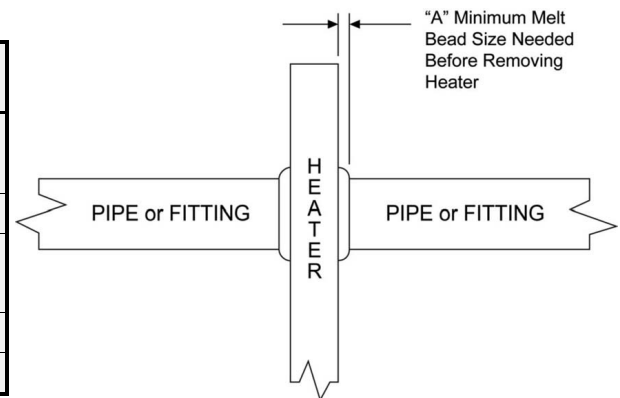

**Table 2: Maximum Heater Plate Removal Times**

Field Applications Pipe Wall Thickness, in. (mm)	Common Gas Pipe OD Sizes	Maximum Heater Plate Removal Time (Seconds)
0.17 to 0.36 (5 to 9)	2” DR 11.0; 3” DR 11.5; 3” DR 11.0	8
> 0.36 to 0.55 (9 to 14)	4” DR 11.0; 4” DR 11.5; 6” DR 13.5	10
> 0.55 to 1.18 (14 to 30)	6” DR 11.0 & 11.5; 8”, 10”, 12” DR 11.0; 11.5; 13.5	15
> 1.18 to 2.5 (30 to 64)		20
> 2.5 to 4.5 (64 to 114)		25

To calculate for Wall Thickness, divide Actual Pipe OD by DR. Wall thickness values are also given in Performance Pipe Size and Dimension Charts.

- **Important:** The maximum heater plate removal time for ½ in. CTS to 1 ½ in. IPS is 4 seconds.
- **Important:** For 14” and larger pipes, a minimum heat soak time of 4.5 minutes per inch of pipe wall thickness and the minimum melt bead size must be achieved.

During heating, the melt bead will expand out flush to the heating tool surface or may curl slightly away from the surface. If the melt bead curls significantly away from the heating tool surface, unacceptable pressure during heating may be indicated.

- **Join.** Immediately after heating tool removal, **quickly** inspect the melted ends, which should be flat, smooth and completely melted. If the melt surfaces are acceptable, immediately and in a continuous

motion, bring the ends together and apply the correct joining force. **Do not slam. Apply enough joining force to roll both melt beads over to the pipe surface.**

A concave melt surface is unacceptable; it indicates pressure during heating. See **Figure 1**. Do not continue. Allow the component ends to cool and start over at Step 1.

**Figure 1**  
**Unacceptable Concave Melt Appearance**

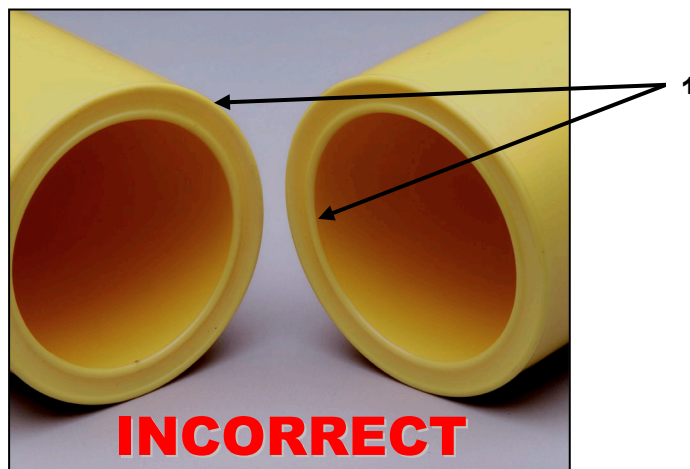

- The correct joining force will form a double bead that is rolled over to the surface on both ends.
- **Hold.** Hold joining force against the ends until the joint is cool. Maintain fusion pressure against the pipe ends at a minimum cool time rate of 11 minutes per inch of pipe wall thickness. **For ambient temperatures above 100°F, additional cooling time may be needed. Do not try to shorten cooling time by applying water, wet cloths or the like.**
  - Avoid high stress on the fusion joint from pulling, installation, pressure testing and rough handling for at least an additional 30 minutes after removal from the fusion machine. For 1" IPS and smaller pipe sizes, only 10 minutes of additional cooling time is required. Do not apply internal pressure until the joint and surrounding material have reached ambient air temperature.
  - Heavier wall thickness pipes require longer cooling times.
- **Inspect.** On both sides, the double bead should be rolled over to the surface and be uniformly rounded and consistent in size all around the joint. Butt fusion bead dimensional guidelines can be seen in **Figure 2**.

- **When butt fusing to molded fittings, the fitting-side bead may have an irregular appearance due to the molded part cooling and knit lines. This is acceptable provided the pipe-side bead is correct.**
- **One bead may be larger than the other when fusing two dissimilar materials. This is acceptable provided both bead sizes are uniform around their respective pipes.**
- **It is not necessary for the internal bead to roll over to the inside surface of the pipe.**

**Figure 2**  
**Butt Fusion Bead Proportions (ASTM F2620)**

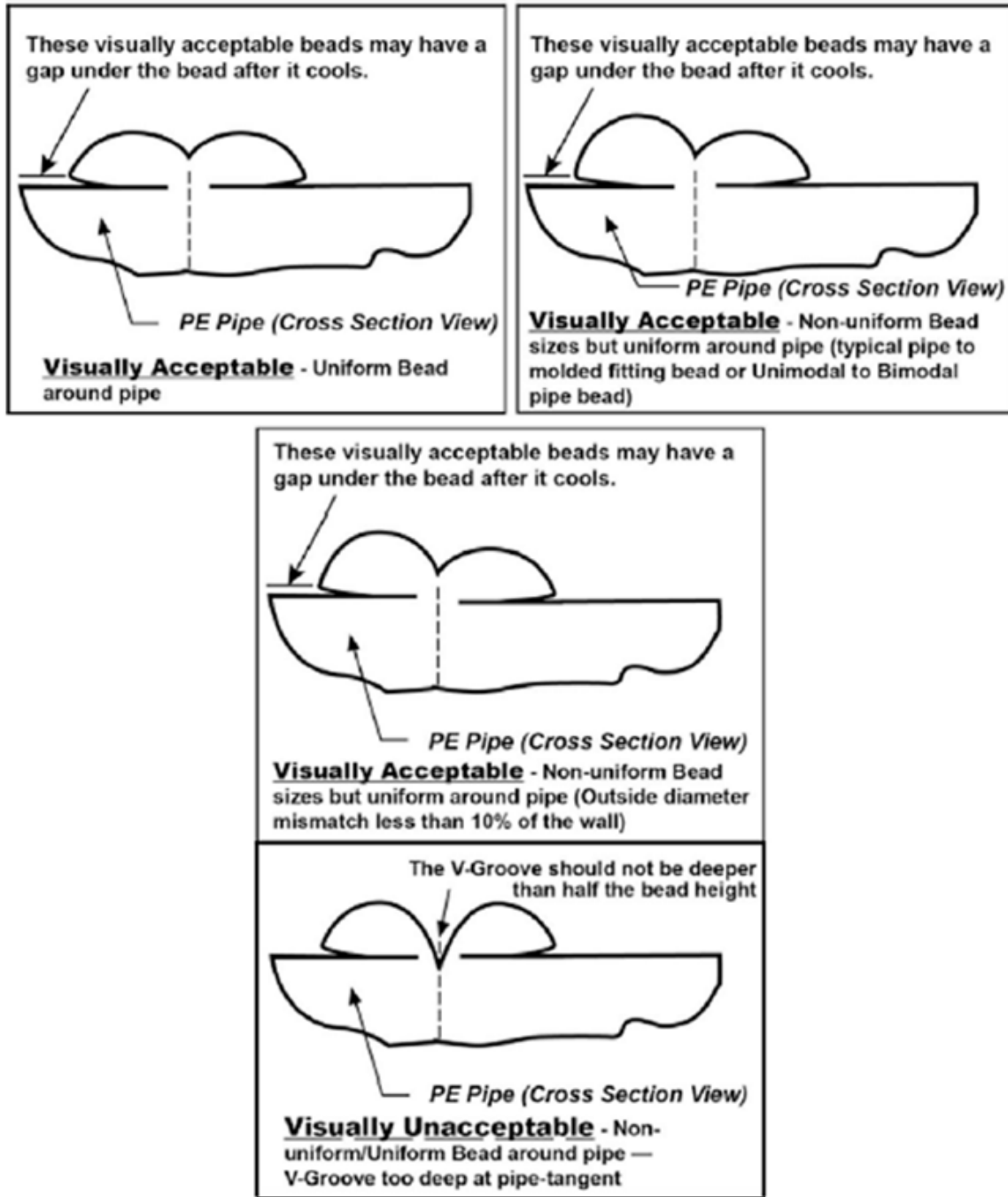

**Table 3: Butt Fusion Bead Troubleshooting Guide**

<b>Observed Condition</b>	<b>Possible Causes</b>
Double bead v-groove too deep	Pressure applied during the heating cycle.
Non-uniform bead size around pipe	Misalignment; defective heating tool; worn equipment; incomplete facing
One bead larger than the other	Different bead sizes are expected when joining different material types, such as heat fusion joining MDPE to HDPE pipes. If the two materials being joined are the same, then having one bead being larger than the other bead may be a sign that the component slipped in clamp; that the heating tool may be defective or that there may be incomplete facing;
Beads too small	Insufficient heating; insufficient joining force
Beads too large	Excessive heating time
Rough, sandpaper-like, bubbly, or pockmarked melt bead surface	Hydrocarbon contamination

**Acceptable Fusions**

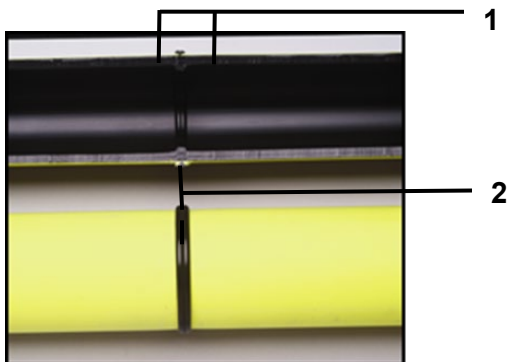

1. Proper double roll-back bead  
2. Proper alignment

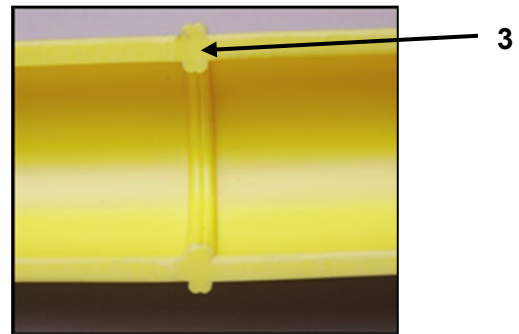

3. Proper double roll-back bead

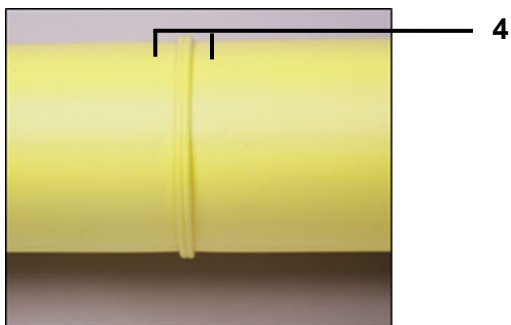

4. Proper alignment

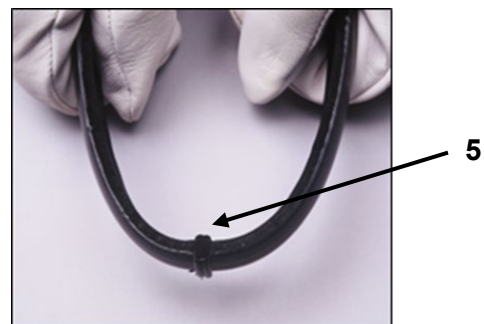

5. No gaps or voids when bent

### Unacceptable Fusions

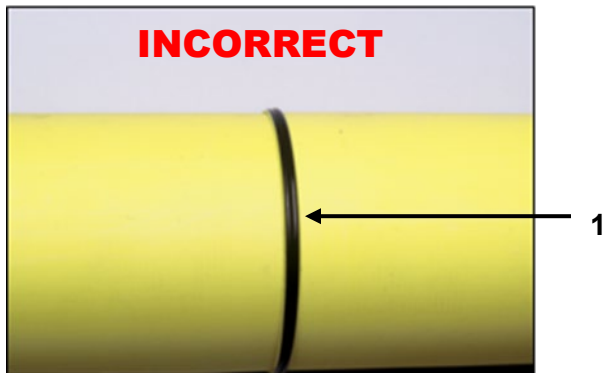

1. Insufficient heat time; melt bead too small

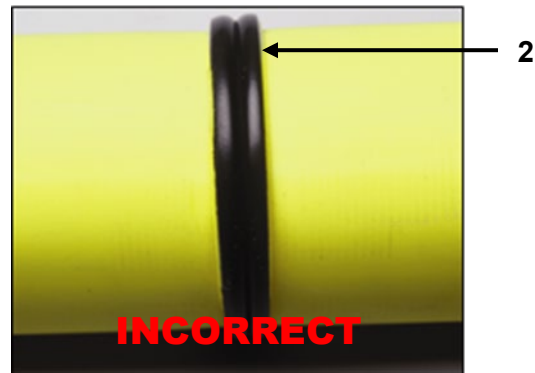

2. Excessive heat time or pressure applies during heating; melt bead too large

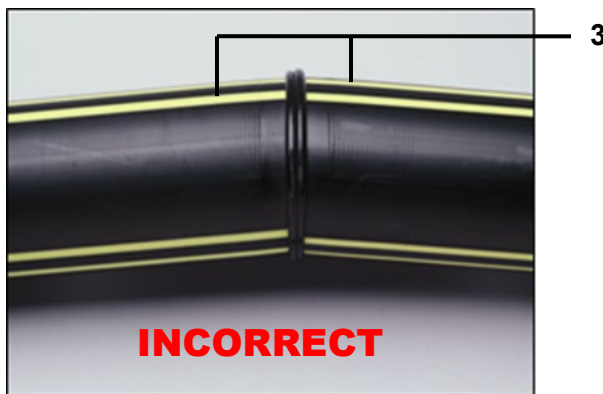

3. Pipe angled into fusion unit



4. Improper "High-Low" alignment

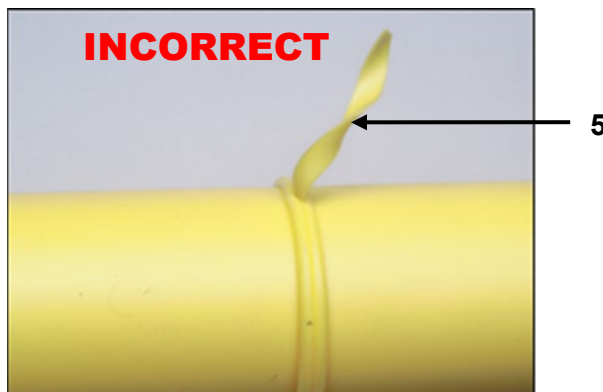

5. Incomplete face off or failure to remove faced off ribbons

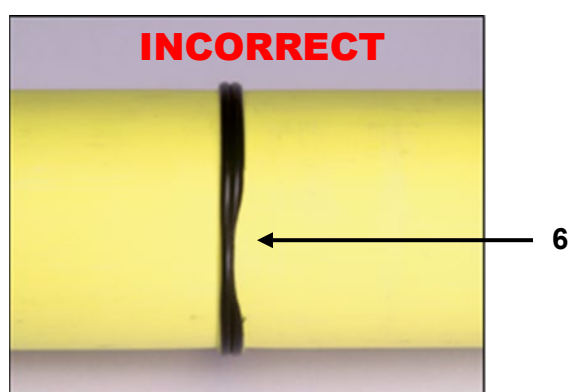

6. Incomplete face off



## BEND BACK TESTING OF BUTT FUSED JOINTS

FOR GAS UTILITIES, REFER TO DOT CFR 192.285 FOR QUALIFYING PERSONS TO MAKE JOINTS.

1. Allow sample joints to cool for no less than one hour.
2. Prepare and cut joint samples into test straps. Please refer to **Figure 3** below. For these qualifying procedures, limit the joint samples to pipe wall thickness of no greater than 1 in. (25 mm).
- ◆ **WARNING** – Bend testing of pipes with a wall thickness greater than 1 in. (25 mm) can be dangerous and should be done with an approved bending fixture that supports and contains the pipe during testing.
3. Visually inspect the cut joint for any indications of voids, gaps, misalignment of surfaces that have not been properly bonded during the fusion process.
4. Bend each test strap at the fusion joint with the inside of the pipe facing out until the ends touch. The test strap must be free of cracks and separations within the fusion joint zone.
5. If flaws are observed in the fusion zone, compare appearance with pictures of unacceptable joints. Prepare a new sample joint using correct joining procedure and repeat the qualifying procedure.

**Figure 3**  
**Butt Bent Strap Test Specimen**

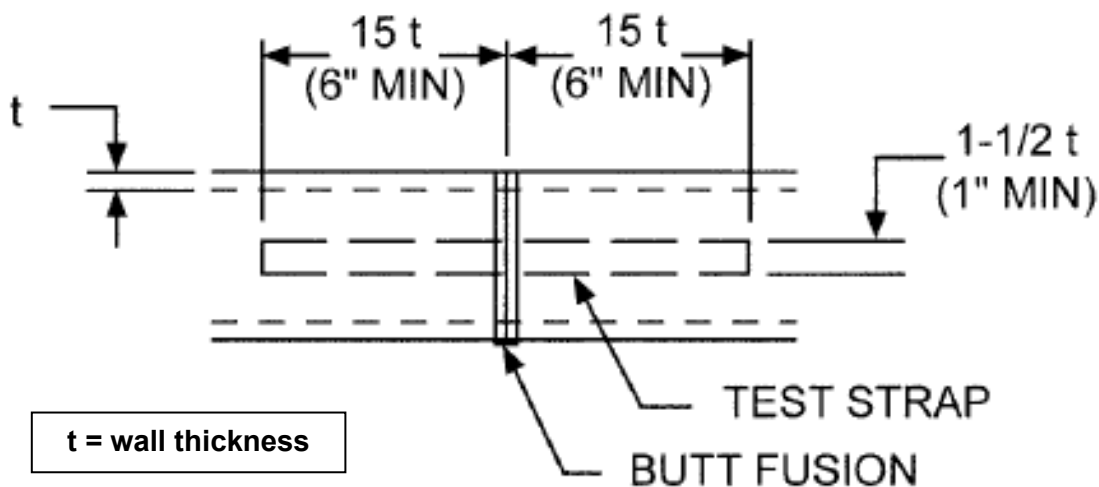

## SADDLE FUSION

### SADDLE FUSION TO A PRESSURIZED MAIN (HOT TAPPING)

As identified in the introduction, this saddle fusion procedure applies to field fusion of Performance Pipe service saddles, tapping tees and branch saddles.

- ◆ **WARNING:** *The possibility of gas main blowout increases when internal pressure is higher, when the pipe wall is thinner (higher DR) and when the temperature of the main is elevated.*

When saddle fusing to a pressurized gas main, gas main internal pressure must not exceed pressure limits specified in Federal regulations (MAOP).

- For Federally regulated gas applications in the United States, main pressure must be reduced for elevated temperature when the main temperature exceeds 100°F (38°C).
- For Federally regulated gas applications in Canada, main pressure must be reduced for elevated temperature when the main temperature exceeds 23°C (73°F).

Saddle fusion to pressurized mains is not recommended for 3" IPS (89mm) mains with DR's above 13.5 and 4" IPS (110 mm) and larger mains with DR's above 17.

### REQUIRED EQUIPMENT

- ✓ A saddle fusion machine (application tool/unit) with appropriate clamps for the main pipe and saddle fitting. Use a main bolster or support for 6" IPS (160 mm) and smaller main pipes.
- ➔ **Important:** When saddle fusing, the saddle fusion machine must have a gauge or mechanism that indicates the force applied when the saddle base is pressed against the heating tool or the main.
- ✓ A heating tool with faces contoured and correctly sized for the main pipe and the fitting base. Both serrated and smooth heater faces will produce quality saddle fusions with the serrated heater faces being preferred.
- ✓ 50-60 grit utility cloth.
- ✓ Timing equipment such as a stopwatch or a watch with a sweeping second hand when fusing to 2" IPS and smaller mains.
- ◆ **WARNING:** *Using improper or faulty equipment, or failing to follow correct saddle fusion procedure during saddle fusion to a pressurized main can result in death, serious injury or property damage.*
- ➔ **Important:** Saddle fusion machines, tools and equipment from different manufacturers will operate differently. Follow the machine manufacturer's instructions for proper use and operation of the equipment.



---

## SET-UP PARAMETERS

### HEATING TOOL SURFACE TEMPERATURE - MINIMUM 490°F – MAXIMUM 510°F (255–265°C)

Low heating tool temperature can lead to a blowout during saddle fusion to a pressurized main. Before you begin, all points on both heating tool surfaces must be within the prescribed minimum and maximum temperatures where the heating tool surfaces will contact the main or the fitting. Heating tool surfaces must be clean.

### SADDLE FUSION PARAMETERS

→ **Important:** Saddle fusion Initial Heat Force (bead-up force), Heat Soak Force and Joining Force are printed on the fitting label and can be found in the Performance Pipe fusion force document online.

**Initial Heat Force (Bead-Up Force).** During the initial heating (bead-up), force is applied to form an initial melt pattern on the main and the fitting base. Initial heating ends when melt is visible at the top center of the main on both sides of the heating tool. Initial Heat Force is usually applied for 3 – 5 seconds, but no more than about 1/3 of the total heating time. The Initial Heat Force in pounds is the first number (XXX) on the fitting label. See **Figure 4**.

**Heat Soak Force.** The Heat Soak Force is always zero. During Heat Soak, the fitting, heating tool and main are held together, but without applying force. The Heat Soak Force is the second number on the fitting label (as depicted in **Figure 4** as “0”).

**Joining Force.** Joining Force (fusion force) is applied to the fitting against the main immediately after the heating tool is removed. Joining Force is half the Initial Heat Force. The Joining Force is the third number (ZZZ) on the fitting label. See **Figure 4**. Joining Force must be maintained for the duration of the first cooling period.

❖ **Caution – Never reduce Joining Force during the first cooling time period. Reducing Joining Force during the first cooling time period may result in blowout during hot tapping.**

➤ If the saddle fusion machine force gauge reading rises during the minimum cooling time period, allow it to do so, see **Step 4** of the Saddle Fusion Procedure section for Minimum Cooling Time.

**Maximum Heating Time.** The heating tool will be placed on the main. Once the fitting is moved against the heater face **AND** the Initial Heat Force (see fitting label) is applied, the heating time is started. The heating time ends when the heating tool is removed from in-between the main and the fitting. When hot tapping 2” IPS and smaller mains, a timing device such as a stopwatch or watch with a sweep second hand is necessary for measuring heating time. See **Table 4** for Maximum Heating Time.

◆ **WARNING – When saddle fusing to a pressurized main, blowout may occur if Maximum Heating Time is exceeded.**

**Minimum Cooling Time.** Cooling time is two successive cooling time periods. During the first cooling time period, Joining Force is applied with the saddle fusion equipment. At the end of the first cooling time period, the application tool may be removed. During the second cooling time period, the joint must be allowed to cool undisturbed. After the second cooling time period, the service or branch line may be connected, or pressure leak tests or tapping may be conducted. See **Step 4** in the procedure for Minimum Cooling Time.

- ◆ **WARNING** – Never reduce *Joining Force* during the first cooling time period, even if *Joining Force* increases on its own.

**Figure 4**  
**Example Fitting Label**

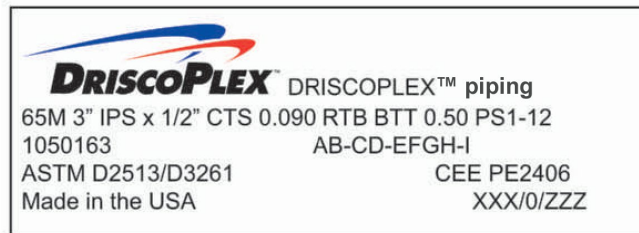

## PROCEDURE

1. **Prepare.** The area of the main pipe where the saddle fusion machine and the fitting will be located must be clean, dry and free of deleterious nicks, gouges or cuts<sup>2</sup>. The application tool must fit on the main pipe without interference or restriction from components or appurtenances, fusion beads or the like. Remove dirt and foreign materials from the main pipe surface. If below grade, the excavation must be large enough to install and operate the Saddle Fusion Machine. The main pipe must not be curved tighter than 100 pipe diameters bending radius.
  - ◆ **WARNING** – *Observe all applicable codes, regulations and safety precautions when working in trenches or other excavations and when working with pressurized gas lines.*
  - Install the saddle application tool on the main pipe according to the tool manufacturer's instructions. The saddle application tool should be centered at the location where the fitting will be fused.
  - Abrade the fusion surface of the fitting base and the mating fusion surface of the main pipe with 50-60 grit utility cloth. On the main surface, abrade a surface area that is the size of the fitting base plus about 1/2-in (13 mm) per side all around. It is necessary to completely remove a thin layer of material from both surfaces. After abrading, brush the residue away with a clean, dry, lint-free, non-synthetic (cotton) cloth. Do not touch abraded and cleaned surfaces with your hands.
  - Regular replacement of the utility cloth is necessary. Worn or dirty utility cloth will not abrade the surface properly. Poor surface preparation can cause poor fusion quality.
  - Install and lightly clamp the fitting in the saddle application tool. (Tapping tee caps may need tightening.) Move the fitting base against the main pipe and apply moderate force (around 100 lbs) to seat the fitting against the main pipe and in the application tool. It may be necessary to wiggle the fitting a little to be sure it is completely seated and squarely aligned against the main. While maintaining force, secure the fitting in the saddle application tool. Move the fitting away from the main pipe.

<sup>2</sup> If used, alcohol wipes are used only before abrading the surface, never after abrading the surface. The surface should be wiped dry with a clean, dry, lint-free, non-synthetic (cotton) cloth, or paper towel after using the alcohol wipe.

2. **Heat.** Verify that the heating tool is between 490°F - 510°F. Place the heating tool on the pipe centered beneath the fitting base and immediately lower the fitting against the heater face. **Do not slam** the fitting against the heating tool. Quickly apply the calculated Initial Heat Force and begin timing. At the first visual indication of melt between heating tool face and the crown of the pipe, reduce force to Heat Soak Force (zero force) and continue timing. Heat the pipe and fitting until the indicated Maximum Heating Time expires or a melt bead of 1/16" is visible around the fitting base. See **Table 4**.

➔ **Important: Use a Flexible Heat Shield for large fittings (>IPS 3" outlet) or large mains (>IPS 6")**

- A Flexible Heat Shield prevents the fitting from overheating while heating a thick main pipe.
- Place the heating tool on the main centered beneath the fitting base, and then place the Flexible Heat Shield between the heating tool and fitting base. (It may be necessary to have an assistant handle the Heat Shield.)
- Apply Initial Heat Force, then when a melt bead is first visible on the main all around the heating tool faces, release the Initial Heat Force, raise the fitting slightly, remove the Heat Shield, move the fitting against the heating tool face, apply Initial Heat Force and start the heat time. When a melt bead is first visible all around the fitting base (**usually** about 3 to 5 seconds), reduce to Heat Soak Force (zero). Maintain Heat Soak Force until at least a 1/16 inch bead is present around the fitting base.

◆ **WARNING – Heating and joining must be performed accurately and quickly, especially when saddle fusing to a pressurized main pipe. Overheating or excessive time between actions can cause a blowout.**

◆ **WARNING – Do not interrupt heating to inspect the melt pattern on the main pipe. When fusing to a pressurized main, this can overheat the main pipe and cause a blowout.**

3. **Join.** When the heating time ends, separate the heating tool from the fitting and the pipe and remove the heating tool. Quickly inspect the melt on the pipe and fitting base. Within 3 seconds move the fitting against the pipe and apply the calculated Joining Force.

4. **Hold.** Maintain the Joining Force for 5 minutes on IPS 1¼" (42 mm) and for 10 minutes on larger sizes. Cool undisturbed for an additional 30 minutes. During this time avoid pressure testing, rough handling, tapping and connecting to the branch outlet.

◆ **WARNING – Blowout – Always join the fitting to a pressurized main pipe after heating. If the fitting is not joined to the main pipe immediately after heating, the pressurized main pipe may rupture.**

- After Joining Force has been applied, **NEVER** reduce Joining Force until the first cooling time period has ended. Do not reduce the application tool Joining Force setting if the value on the application tool gauge rises.
- The saddle fusion machine may be removed after the first cooling time period has ended.

5. **Inspect.** Visually check the fusion bead around the entire fitting base at the main pipe. The fusion bead should be uniformly sized all around the fitting base and should have a characteristic “three-bead” shape. Refer to Image #1 under the Acceptable Fusion section. The first bead is the fitting base melt bead. The second or outermost bead is produced by the edge of the heating tool face on the main. The third or center bead is the main pipe melt bead. The first and third beads should be about the same size all around the fitting base. If the melt on the main pipe or the fitting base was unacceptable, the saddle fusion should not be placed in service. Please see **Table 5** for troubleshooting of irregular bead performance and/or appearance.

**Table 4: Saddle Fusion Parameters**

Sequence	Parameter
Heater Adapter Surface Temperature	500 ± 10°F (260 ± 6°C)
Initial Interfacial Pressure	60 ± 6 psi (4.14 ± 0.41 bar); <i>Calculate or See Fitting Label</i>
Heat Soak Interfacial Pressure	0 psi; <i>Calculate or See Fitting Label</i>
Fusion Interfacial Pressure	30 ± 3 psi (2.07 ± 0.20 bar); <i>Calculate or See Fitting Label</i>
Maximum Heating Time on Pressurized Main – 1-1/4” IPS	15 seconds <b>Max</b>
Maximum Heating Time on Pressurized Main – 2” IPS	25 to 35 seconds <b>Max</b>
Maximum Heating Time on Non-Pressurized Main – 1-1/4” and 2” IPS Maximum Heating Time on Pressurized and Non-Pressurized Mains – 3” IPS and Larger	Look for a 1/16 in (1.6 mm) bead around the fitting base

**Table 5: Saddle Fusion Bead Troubleshooting Guide**

Observed Condition	Possible Cause
Non-uniform bead size around fitting base	Misalignment; defective heating tool; loose or contaminated heating tool saddle faces; worn equipment; fitting not secured in application tool; heating tool faces not within specified temperature
One bead larger than the other	Misalignment; component slipped in clamp; worn equipment; defective heating tool; loose or contaminated heating tool saddle faces; heating tool faces not within specified temperature
Beads too small	Insufficient heating; insufficient joining force
Beads too large	Excessive heating time; excessive force
No second bead (or outermost bead)	Incorrect pipe main heating tool face
Serrated bead appearance	Normal for serrated heating tool faces
Smooth bead appearance	Normal for smooth heating tool faces
Pressurized main pipe blowout (beside base or through fitting center)	Overheating; incorrect heating tool faces; heating tool faces not within specified temperature; taking too much time to start heating (Step 2e), or to remove the heating tool and join the fitting to the main pipe (Step 3g);
Rough, sandpaper-like, bubbly, or pockmarked melt bead surface	Hydrocarbon contamination
No third (or center) bead	Insufficient joining force



## Acceptable Fusions

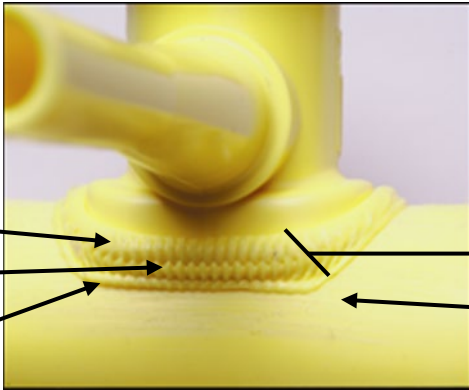

1. Proper alignment, force and melt
2. Proper pipe surface preparation

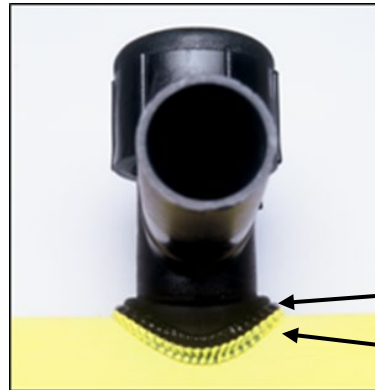

3. Proper alignment, force and melt
4. Proper pipe surface preparation



5. Melt bead below or parallel with top of fitting base

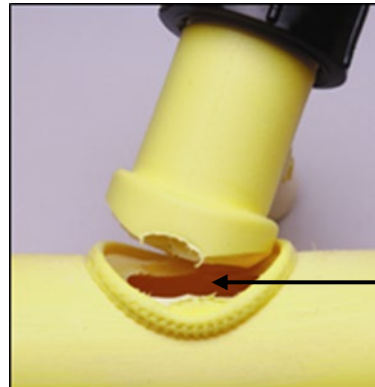

6. Material pulled from pipe when impact tested

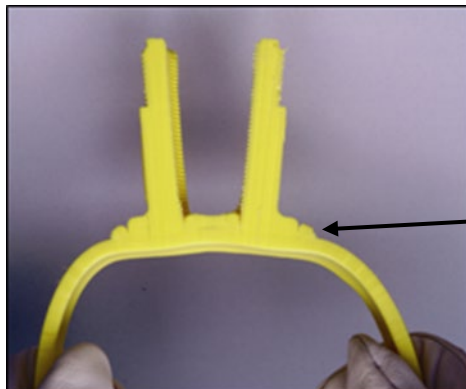

7. No gap or voids when bent

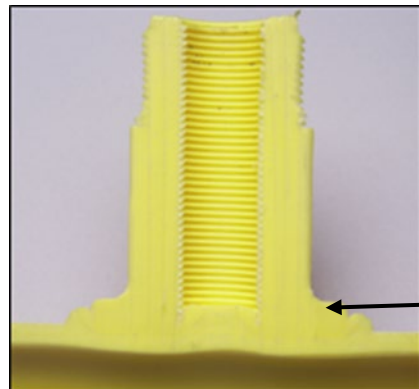

8. No gaps or voids at fusion interface

### Unacceptable Fusions

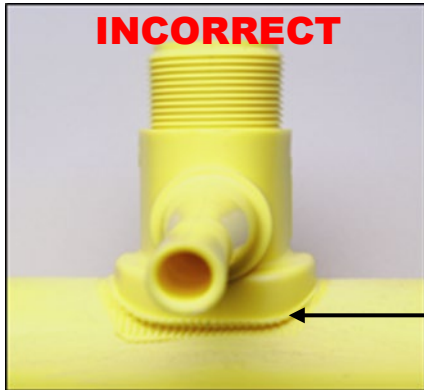

1. Insufficient melt and misaligned

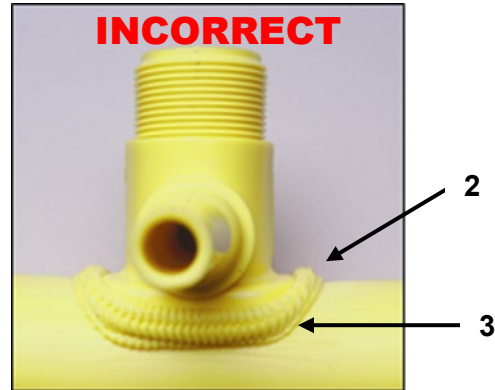

2. Bead above base of fitting  
3. Excessive melt and force

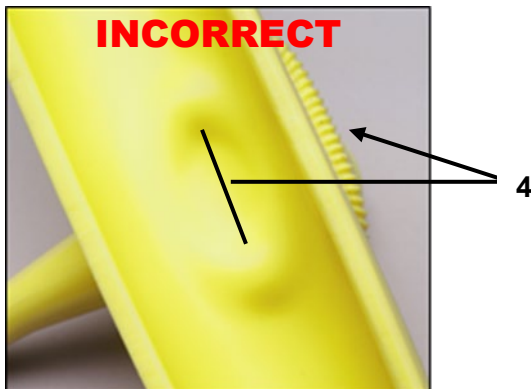

4. Excessive melt and force

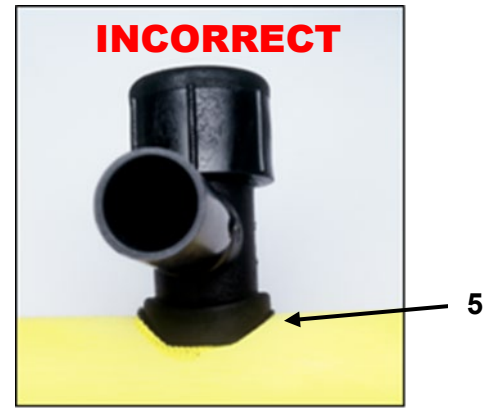

5. Insufficient melt

## BEND BACK TESTING OF SADDLE FUSED JOINTS

FOR GAS UTILITIES, REFER TO DOT CFR 192.285 FOR QUALIFYING PERSONS TO MAKE JOINTS.

1. Prepare fusion joint samples. Pipe on either side of the fitting should extend at least 6" (150 mm) or 15 times the wall thickness in length. Please refer to **Figure 5** below. For these qualifying procedures, limit the joint samples to pipe wall thickness of no greater than 1 in. (25 mm). Observe the joining process to determine that the correct procedure is being followed.

◆ **WARNING** – Bend testing of pipes with a wall thickness greater than 1 in. (25 mm) can be dangerous and should be done with an approved bending fixture that supports and contains the pipe during testing.

2. Allow the sample joints to cool for no less than one hour.
3. Cut sample joint lengthwise along the main pipe and through the saddle fitting to prepare a test strap. Please refer to **Figure 5**.
4. Visually inspect the cut joint for any indications of voids, gaps, misalignment of surfaces that have not been properly bonded during the fusion process.
5. Bend test straps at the fusion joint as pictured above. The test strap joint must be free of cracks and separations within the fusion zone.
6. If flaws are observed in the fusion zone, compare appearance with pictures of unacceptable joints. Prepare new sample joints using correct joining procedure and repeat the qualifying procedure.

### Alternate Bend Back Testing of Saddle Fused Joints

Test a sample joint by impact against the saddle fitting. Failure must occur by tearing the fitting or bending the fitting at least 45° or removing a section of wall from the main pipe. Failure along the fusion bond line is not acceptable. (Federal regulations require impact tests for procedure qualification, but not for individual qualification.) Refer to ASTM F905.

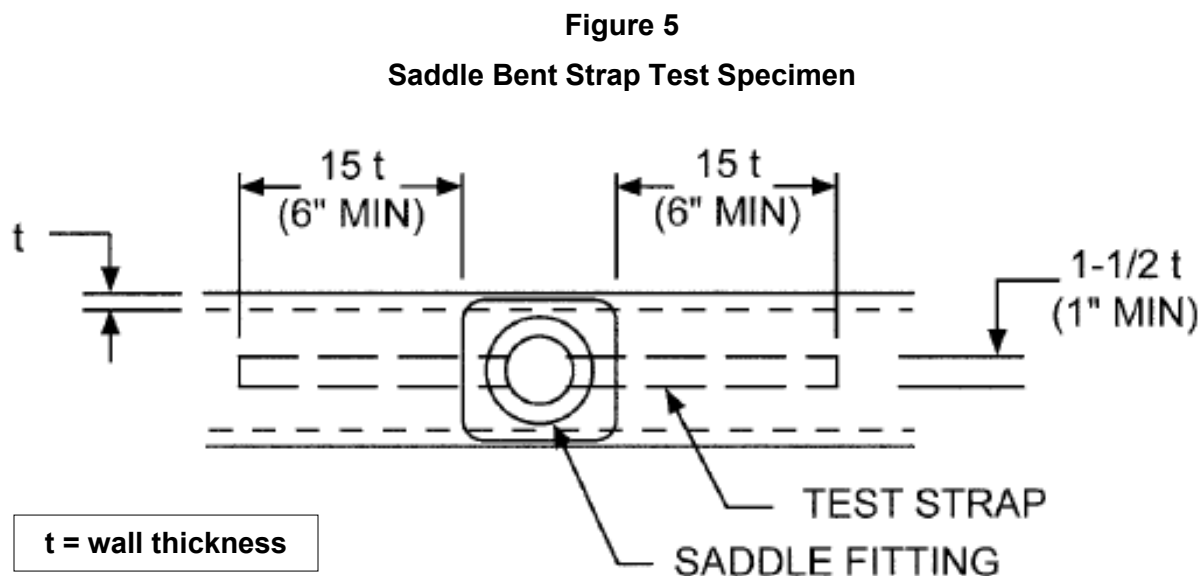

## SOCKET FUSION

### REQUIRED EQUIPMENT

This procedure requires: Chamfering tool, depth gauge (some manufacturers combine chamfering tool and depth gauge), cold ring clamp, heating tool with male and female socket faces, and timing equipment (such as a watch with a second hand). Holding tools are desirable for 2" IPS (90 mm OD) and larger pipe and fittings. Clean work gloves are suggested.

- ✓ Heating tool male and female socket faces should meet ASTM F1056 *Socket Fusion Tools for Use in Socket Fusion Joining Polyethylene Pipe or Tubing and Fittings*.

### SET-UP PARAMETERS

#### HEATING TOOL SURFACE TEMPERATURE - MINIMUM 490°F – MAXIMUM 510°F (255–265°C)

- Where heating tool surfaces will contact the main or the fitting, all points on both heating tool surfaces must be within the prescribed minimum and maximum temperatures before you begin.
- Molten PE material may be cleaned from heating tool faces with a wooden implement such as a tongue depressor. To remove burned or charred material from socket faces, heat the faces, insert a short length of pipe or tubing into the female face and a socket fitting onto the male face. Then unplug the heating iron and let it cool completely. When the pipe or tubing and the fitting are removed from the cold heating tool, the burned or charred material will come off with them.

### PROCEDURE

1. **Clean and Cut.** Clean the inside and outside of the pipe and fitting with a clean, dry, lint-free, non-synthetic (cotton) cloth, or paper towel. Do not touch cleaned surface with your hands. The pipe or tubing end must be squarely cut. If the end is not squarely cut, use a plastic pipe cutter or hand saw and cut the pipe or tubing end squarely.
  - When using a wheel-type pipe cutter, be sure the cutter wheel does not thread down the pipe – cut off all partial cuts before fusion.
2. **Chamfer.** For all pipe and tubing sizes, chamfer the end to remove the sharp outer edge on the OD. Remove all burrs from inside of pipe ends. Make sure the pipe or tubing end is clean, dry and free of foreign substances. Wipe with a clean, dry, lint-free, non-synthetic (cotton) cloth, or paper towel. Do not touch cleaned surfaces with your hands.
3. **Round.** Place the depth gauge snugly over the chamfered end of the pipe and clamp the cold ring clamp on the pipe OD immediately behind the depth gauge. Remove the depth gauge
  - In socket fusion, there is an interference fit between the pipe or tubing and the socket, that is, the socket is slightly smaller than the pipe. They won't fit together cold.
  - Heating tool faces are tapered which produces a tapered melt. Therefore, the pipe or tubing and the fitting will tend to push away from the heating tool during heating and will tend to push apart when first joined together. It is necessary to hold the pipe and fitting against the heater faces during heating and to hold them together when fusing.

- When using a socket coupling to join coiled pipe, if possible “S” the pipes on either side of the coupling to compensate for coil curvature and make it easier to join the second pipe to the coupling.
4. **Heat.** Verify that the heating tool is between 490°F- 510°F. Push the socket fitting onto the male socket face. **DO NOT TWIST.** The socket fitting must bottom out completely and be held against the back surface of the male heater face. Then and only then, push the pipe or tubing end into the female socket face. **DO NOT TWIST.** The cold ring clamp must be completely against the female socket face and held in place. Heating time starts when the cold ring is against the female heater face and when pipe and fitting are fully inserted. Heat the pipe end and the fitting socket for the time required in **Table 6.**
- **Important:** For socket fusion joining of medium density to high density, pre-heat the high density component. This pre-heat time can be found by subtracting the shorter heating time (medium density) from the longer heating time (high density). If heating times are within 10% of each other, the longer heating time may be used for both components.<sup>3</sup>
5. **Join.** At the end of the heating time, quickly remove the pipe and fitting from the Heating Tool simultaneously using a snap action. **DO NOT TWIST.** Inspect the melt pattern on the pipe and fitting socket. The surfaces should be 100% melted with no cold spots. Within 3 seconds after removing from the heating tool, firmly push the pipe end and the fitting socket straight together, **DO NOT TWIST PIPE OR FITTING,** until the cold ring clamp makes firm contact with the end of the fitting socket.
- **Important:** Remove the pipe and the fitting straight out from the heating tool faces. Do not displace the melt. If the pipe or fitting are removed at an angle or twisted, melt can be displaced, and the joint may leak or fail. Grasp the pipe behind the cold ring clamp. Pulling on the cold ring clamp handle can cause slippage or displace the melt.
- If the melt is not complete, do not continue with the joint. Cut off the melted pipe end, use a new fitting and start over from Step 1. **Do not re-use a melted fitting.** If the melt is correct, continue the joining procedure.
  - Grasp the pipe behind the cold ring clamp. Pushing on the cold ring clamp handle can cause slippage or a crooked joint.
6. **Hold.** Hold the pipe and socket fitting firmly together until the **Table 6** cooling time has been met. **DO NOT TWIST PIPE OR FITTING.** For ambient temperatures 100°F and higher, additional cooling time may be needed. Remove the rounding clamp and inspect the end of the socket fitting at the pipe for a complete impression of the rounding clamp in the melt surface. Allow the joint to cool for an additional 5 minutes before exposing the joint to any type of stress (ex: burial, testing or fusing the other end of the fitting, etc.).
- **Important:** Push the pipe and fitting straight together. If joined at an angle or misaligned, the joint may leak or fail.

---

<sup>3</sup> The Guideline for the joining of unlike materials is based on PPI TN-13/2007 General Guidelines for Butt, Saddle, and Socket Fusion of unlike Polyethylene Pipes and Fittings.

- Clean heater faces carefully after each fusion with a wooden implement such as a tongue depressor to remove any molten PE from the male and female socket faces.

7. **Inspect.** Inspect the end of the socket fitting at the pipe. There should be a clear impression of the cold ring clamp into the melt ring at the end of the fitting with no visible gaps or voids around the pipe at the socket melt ring. The pipe and fitting should be aligned straight with each other. Use **Table 7** for common socket fusion problems. If flaws are observed in the joint, find the cause of the flaw and repeat the procedures to prepare a new joint.

→ **Important:** For installation purposes, the pipe bend radius should be kept to 100 times the outside diameter when a socket fusion fitting is present to avoid over stressing the pipe and/or fitting connection

**Table 6: Socket Fusion Heating & Cooling Times**

Pipe Size	PE 2406 / PE 2708		PE 3408 / PE 3608 / PE 4710	
	Heating Time, seconds	Cooling Time, seconds	Heating Time, seconds	Cooling Time, seconds
1/2" CTS	6 – 7	30	6 – 10	30
3/4" CTS	6 – 7	30	6 – 10	30
1" CTS	9 – 10	30	9 – 16	30
1-1/4" CTS	10 – 12	30	10 – 16	30
1/2" IPS	6 – 7	30	6 – 10	30
3/4" IPS	8 – 10	30	8 – 14	30
1" IPS	10 – 12	30	15 – 17	30
1-1/4" IPS	12 – 14	45	18 – 21	60
1-1/2" IPS	14 – 17	45	20 – 23	60
2" IPS	16 – 19	45	24 – 28	60
3" IPS	20 – 24	60	28 – 32	75
4" IPS	24 – 29	60	32 – 37	75



**Table 7: Socket Fusion Troubleshooting Guide**

<b>Observed Condition</b>	<b>Possible Cause</b>
No cold-ring impression in socket fitting melt bead	Depth gauge not used; cold ring not used, or set at incorrect depth; Insufficient heat time
Gaps or voids around pipe at socket fitting edge	Pipe or fitting not removed straight from heater face (twisting or removing from heater face at an angle); pipe or fitting not inserted straight into each other when fusing; Joining together at an angle; twisting while joining pipe and fitting together; cold ring not used or set too deep
Wrinkled or collapsed pipe or tubing end ( <i>when viewed from inside, or when qualifying lengthwise cut joint</i> )	Incorrect heating sequence – always push the pipe or tubing into the heater <b>after</b> the fitting has been pushed on the heater (inserting the tubing first heats the tubing too long); cold ring set too deep; cold ring not used
Voids in fusion bond area ( <i>when qualifying lengthwise cut joint</i> )	Pipe or fitting not removed straight from heater face (twisting or removing from heater face at an angle); pipe or fitting not inserted straight into each other when fusing; joining together at an angle; twisting while joining pipe and fitting together; cold ring not used or set too deep
Unbonded area on pipe or tubing at end of pipe or tubing ( <i>when qualifying lengthwise cut joint</i> )	Cold ring not used or set too deep
Socket melt extends past end of pipe or tubing ( <i>when qualifying lengthwise cut joint</i> )	Cold ring set too shallow
Rough, sandpaper-like, bubbly, or pockmarked melt bead surface	Hydrocarbon contamination

**Acceptable Appearance**

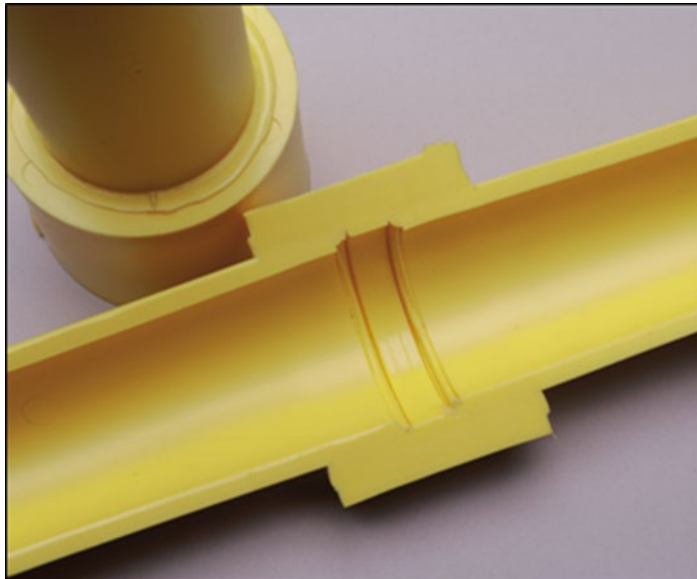

### Acceptable Fusions

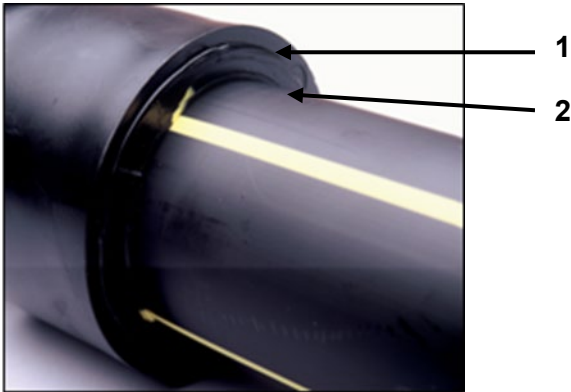

- 1. Melt bead flattened by cold ring
- 2. No gaps or voids

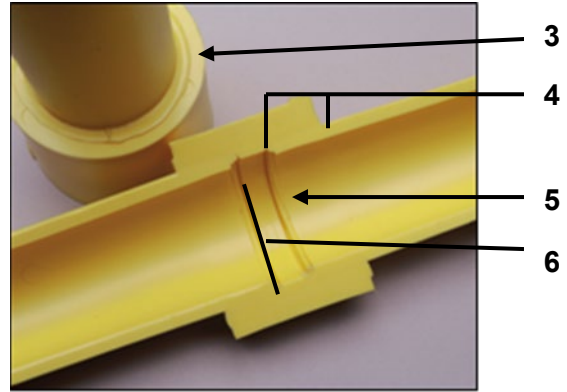

- 3. No gap or voids
- 4. Proper insertion depth
- 5. Acceptable internal fusion bead
- 6. Complete internal melt bead

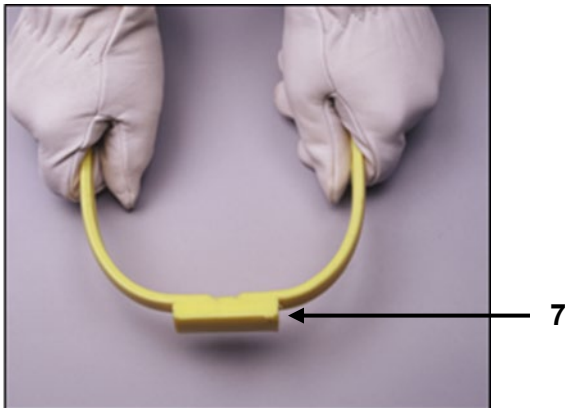

- 7. No gap or voids

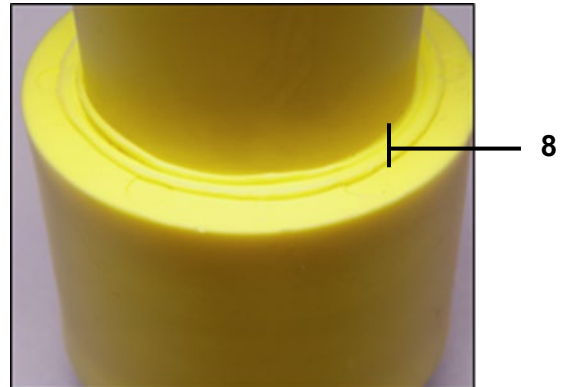

- 8. Melt bead flattened by cold ring

## Unacceptable Fusions

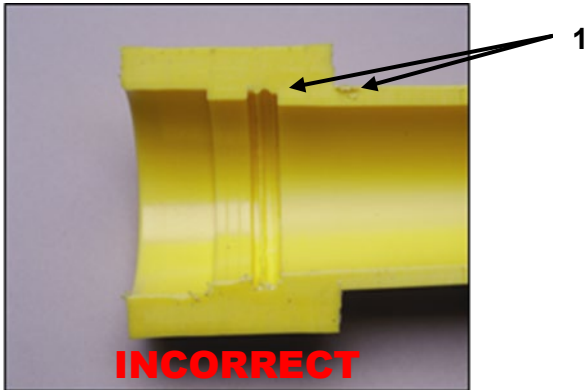

1. Improper insertion depth/short stab depth

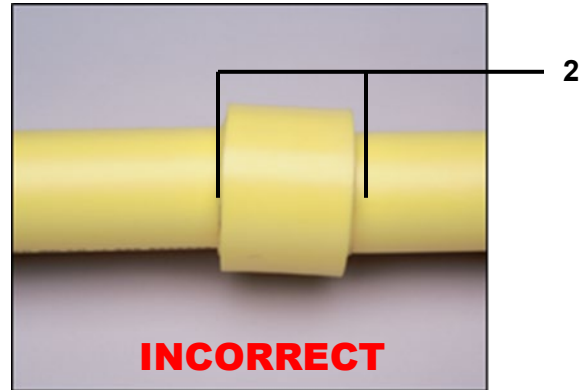

2. Misalignment

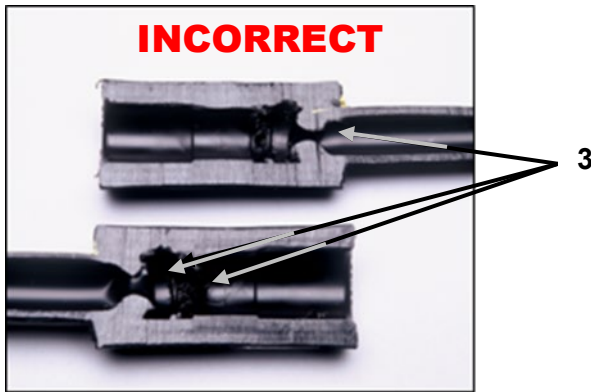

3. Excessive heating

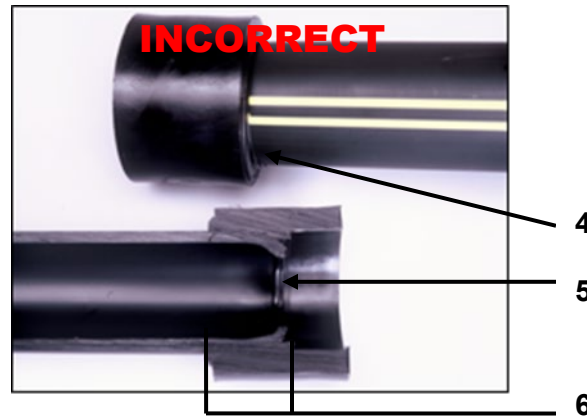

4. Melt bead not flattened against fitting/no cold ring  
 5. Improper insertion depth/no cold ring  
 6. Excessive heating

## BEND BACK TESTING OF SOCKET FUSED JOINTS

FOR GAS UTILITIES, REFER TO DOT CFR 192.285 FOR QUALIFYING PERSONS TO MAKE JOINTS.

1. Prepare fusion joint samples. Pipe on either side of the fitting should extend at least 6" (150 mm) or 15 times the wall thickness in length. Please refer to **Figure 6** below. For these qualifying procedures, limit the joint samples to pipe wall thickness of no greater than 1 in. (25 mm). Observe the joining process to determine that the correct procedure is being followed.
- ◆ **WARNING** – Bend testing of pipes with a wall thickness greater than 1 in. (25 mm) can be dangerous and should be done with an approved bending fixture that supports and contains the pipe during testing.
2. Allow the sample joints to cool for no less than one hour.
3. Cut sample joint lengthwise along the main pipe and through the saddle fitting to prepare a test strap. Please refer to **Figure 6**.
4. Visually inspect the cut joint for any indications of voids, gaps, misalignment of surfaces that have not been properly bonded during the fusion process.
5. Bend test straps at the fusion joint as pictured above. The test strap joint must be free of cracks and separations within the fusion zone.
6. If flaws are observed in the fusion zone, compare appearance with pictures of unacceptable joints. Prepare new sample joints using correct joining procedure and repeat the qualifying procedure.

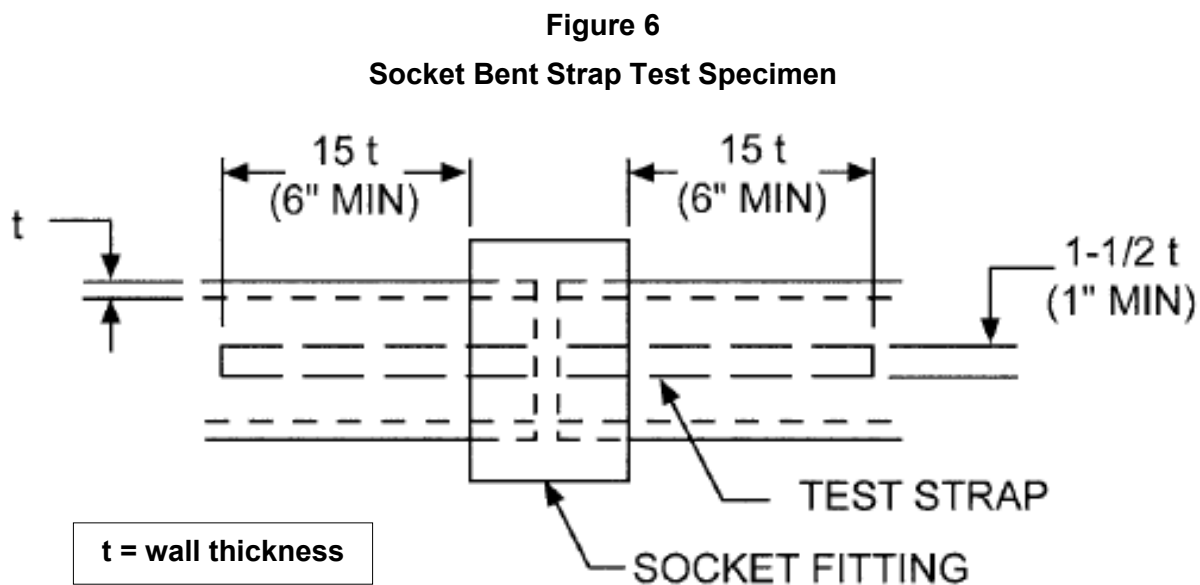

# When Performance Matters Rely on *Performance Pipe*

## **Contact Information**

**Performance Pipe**  
**A division of Chevron Phillips Chemical Company LP**  
5085 W. Park Blvd., Suite 500, Plano, TX 75093  
Phone: 800-527-0662 | Fax: 972-599-7329

Visit Performance Pipe on the web for the latest literature updates:

[www.performancepipe.com](http://www.performancepipe.com)



**NOTE:** By using any Technical Information contained herein, Recipient agrees that said Technical Information is given by Performance Pipe, a division of Chevron Phillips Chemical Company LP for convenience only, without any warranty or guarantee of any kind, and is accepted and used at your sole risk. Recipients are encouraged to verify independently any such information to their reasonable satisfaction. As used in this paragraph, "Technical Information" includes any technical advice, recommendations, testing, or analysis, including, without limitation, information as it may relate to the selection of a product for a specific use and application.